















## 540 HORIZONT X-CNC 41x1,3

						
0°	45°	60°	45°	60°	$\frac{b}{a \times b}$	
	540	510	350	510	310	x
	400*	280*	200*	280*	190*	x
	750x490	510x490	350x490	510x490	310x490	750x450
						
3x400V 50 Hz	5,5	15-150	6880x41x1,3	4000		
Lmax 4696	B 6013	Hmin 2400	Hmax 2510	V 810		



STANDARD    OPTION

<b>540-F</b> 	<b>540-DRIVE</b> 	<b>540-H-WRS</b> 	<b>540-NPH-2</b> 	<b>540-IRP</b> 	<b>540-BSB SERVO</b> 
<b>540-BSF SERVO</b> 	<b>PEGAS ARP</b> 	<b>PEGAS ASR</b> 	<b>PEGAS RZP</b> 	<b>540-CDC</b> 	<b>540-HPV</b> 
<b>540-PCK</b> 	<b>LED</b> 	<b>540-RTS-A</b> 	<b>540-PUH</b> 	<b>540-PUD</b> 	<b>540-OCF</b> 
<b>PCP</b> 	<b>BLUEBOX</b> 	<b>540-HM-DRIVE</b> 	<b>540-KKR</b> 	<b>540-IMB</b> 	<b>540-H-ECK</b> 
<b>MINILUBE 41</b> 	<b>LASER LINE</b> 	<b>540-LHS</b> 	<b>540-H-ATB</b> 	<b>540-CLT</b> 	<b>540-HP1/HP2</b> 

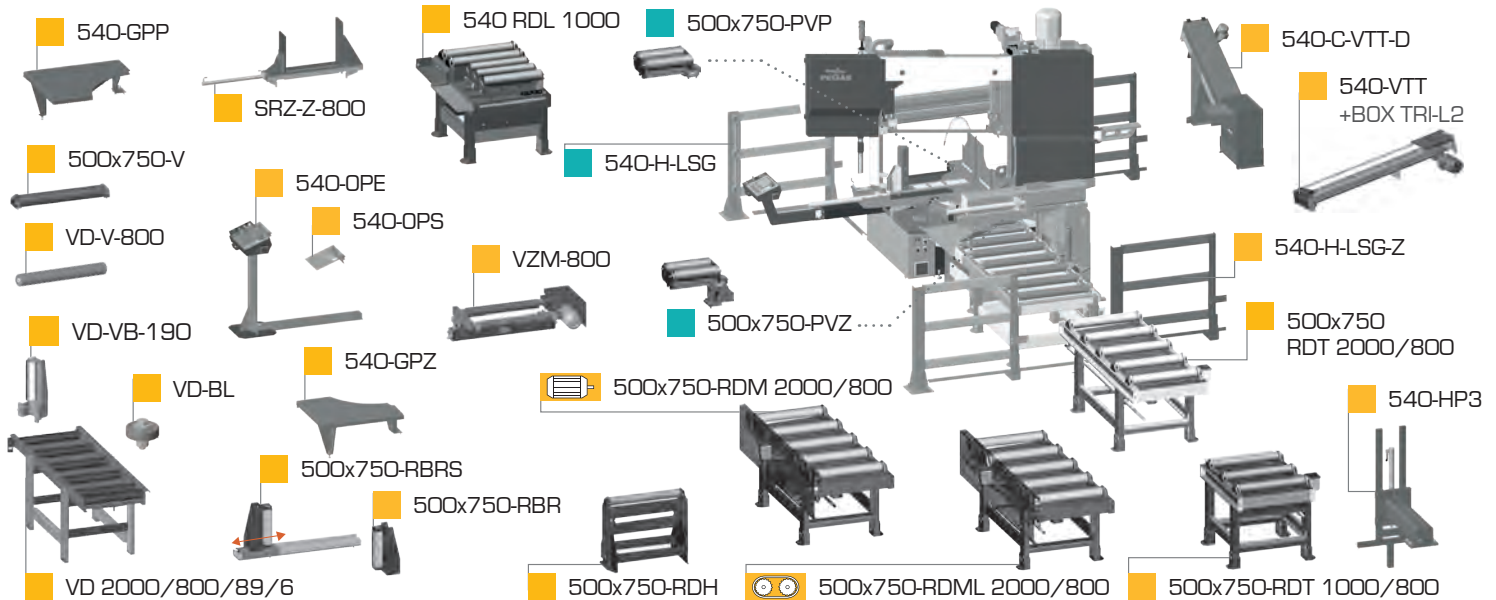

CONTROL PANEL: SIEMENS (X-CNC)

## 540 HORIZONTAL X-CNC

- výrobce si vyhrazuje právo provádět změny technických údajů, technické údaje odpovídají 1.1.2020 / producer has the right to make changes of technical data, technical data are valid on 1.1.2020

- pila na fotografii není vždy v základním provedení, uvedené rozměry odpovídají stroji v základním provedení / the machine in the picture is not always in the basic version, mentioned diameters are for machine in basic version

\* doporučená hodnota. Při překročení doporučeného maximálního průměru není možné garantovat výkon pilového pásu!

/ recommended value. The blade performance cannot be guaranteed when the recommended diameter is exceeded!

- řezání svazků bez horního přitlačení / cutting of the bundle without top clamping



PEGAS - GONDA s.r.o.  
Čs.armády 322, 684 01 Slavkov u Brna,  
CZECH REPUBLIC

[www.pegas-gonda.cz](http://www.pegas-gonda.cz)  
00420-544 221 125 (126) | [pegas@gonda.cz](mailto:pegas@gonda.cz)